

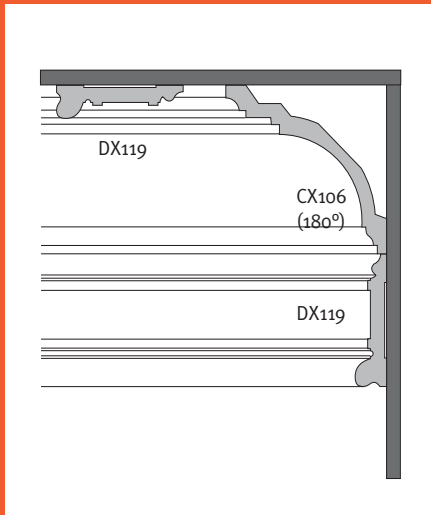













THE ORAC USER MANUAL



THE ORIGINAL

3.7 usage of various lamps

lamp type*		lamp cap	remark	ORAC application
T5 HE 14W		G5	several white colors + RGB	IL001-002
T5 HE 28W		G5	several white colors + RGB	IL001-004
Compact Fluorescent 18W		G24-q2	several white colors	L600-001 up/downlight
T11 halogen 60W		R7s		L600-002 uplight only
T11 halogen 100W		R7s		L600-002 uplight only
Mycro-Lynx F 7W		GX53	3 white colors	L601-001
Mycro-Lynx F 7W red		GX53		L601-001
Mycro-Lynx F 7W blue		GX53		L601-001
Mycro-Lynx F 7W green		GX53		L601-001
Mycro-Lynx LED white clear		GX53	5 colors	L601-001
set of 5 LED inserts 1W + convertor				various mouldings (see page 18)

* lamps not
supplied by ORAC